



**AMERICAN CRANE
& EQUIPMENT CORPORATION**
DOUGLASSVILLE, PA. 19518 U.S.A.
PHONE: 610-385-6061
FAX: 610-385-3191

**TOP RUNNING TROLLEY
W/ OPEN DECK HOIST**

PRODUCT INFORMATION

DWG. NO:

A-20418-7015

15 TON CAPACITY

DATE: 07/20/09

REVISION: 0

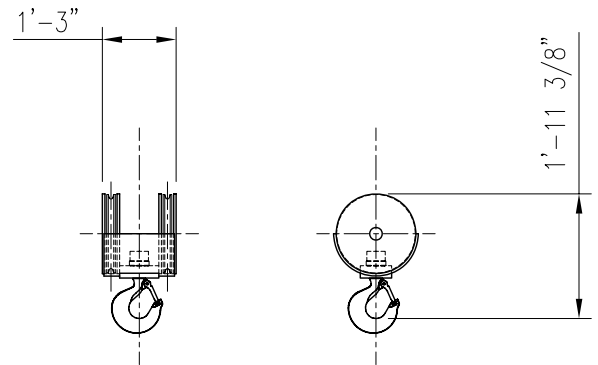
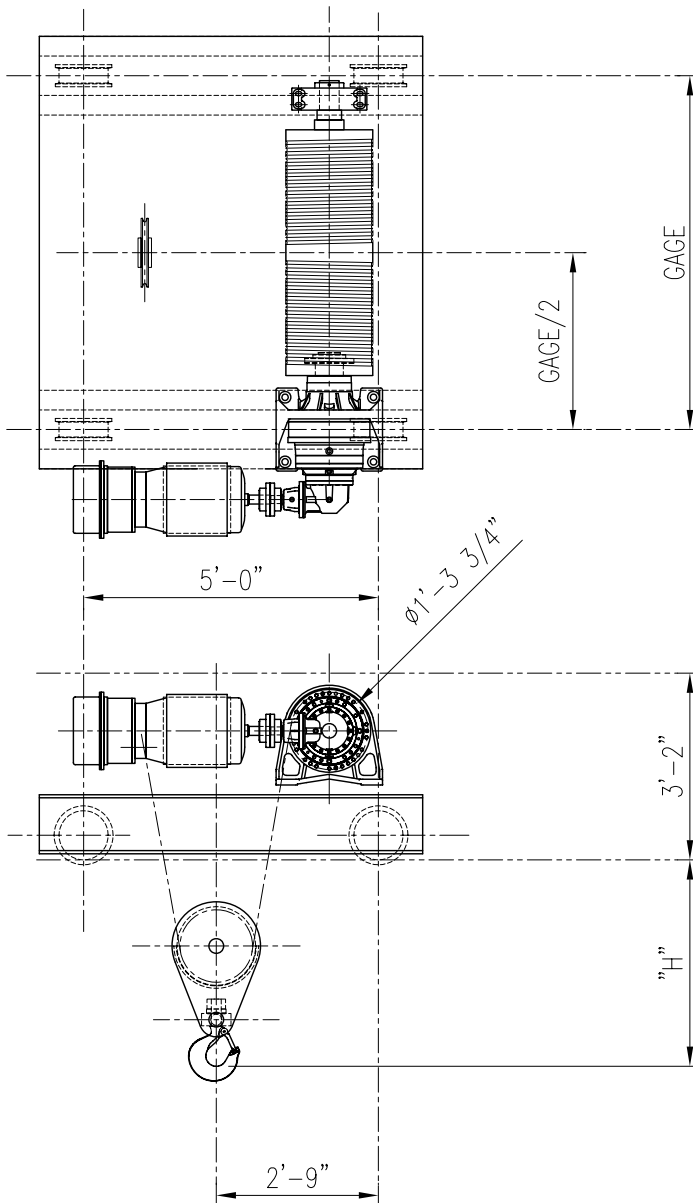

LOW HEADROOM BLOCK

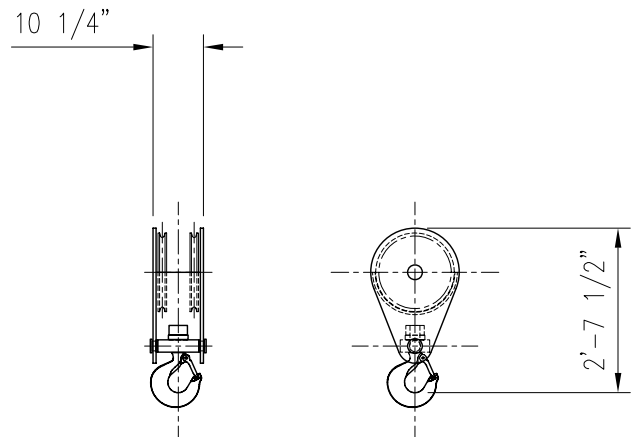

STANDARD HEADROOM BLOCK

ACECO RESERVES THE RIGHT TO MAKE CHANGES WITHOUT NOTICE.

HOIST TECHNICAL DATA

CAPACITY	15 TONS (30,000 LBS.)	HOIST SPEED	MOTOR DATA
		25 F.P.M.	30 HP / 1800 RPM
		16 F.P.M.	20 HP / 1800 RPM
CLASS	CMAA CLASS "D"	12 F.P.M.	15 HP / 1800 RPM
POWER SUPPLY	460V-3PH-60HZ		

DIMENSIONAL INFORMATION

MODEL NUMBER	GAGE	HEIGHT OF LIFT ON HOIST		H	
		STANDARD HEADROOM LOWER BLOCK	LOW HEADROOM LOWER BLOCK	STANDARD HEADROOM LOWER BLOCK	LOW HEADROOM LOWER BLOCK
20418-8015-5	5'-0"	37'-0"	29'-0"	3'-4"	2'-8"
20418-8015-6	6'-0"	55'-6"	47'-6"		
20418-8015-7	7'-0"	74'-0"	66'-6"		