



**AMERICAN CRANE
& EQUIPMENT CORPORATION**
DOUGLASSVILLE, PA. 19518 U.S.A.
PHONE: 610-385-6061
FAX: 610-385-3191

**TOP RUNNING TROLLEY
W/ OPEN DECK HOIST**

5 TON CAPACITY

PRODUCT INFORMATION

DWG. NO:

A-20418-7005

DATE: 07/20/09

REVISION: 0

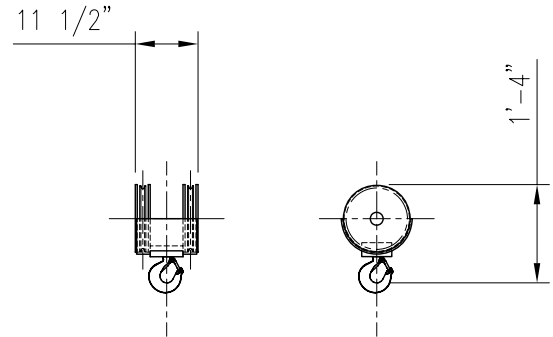
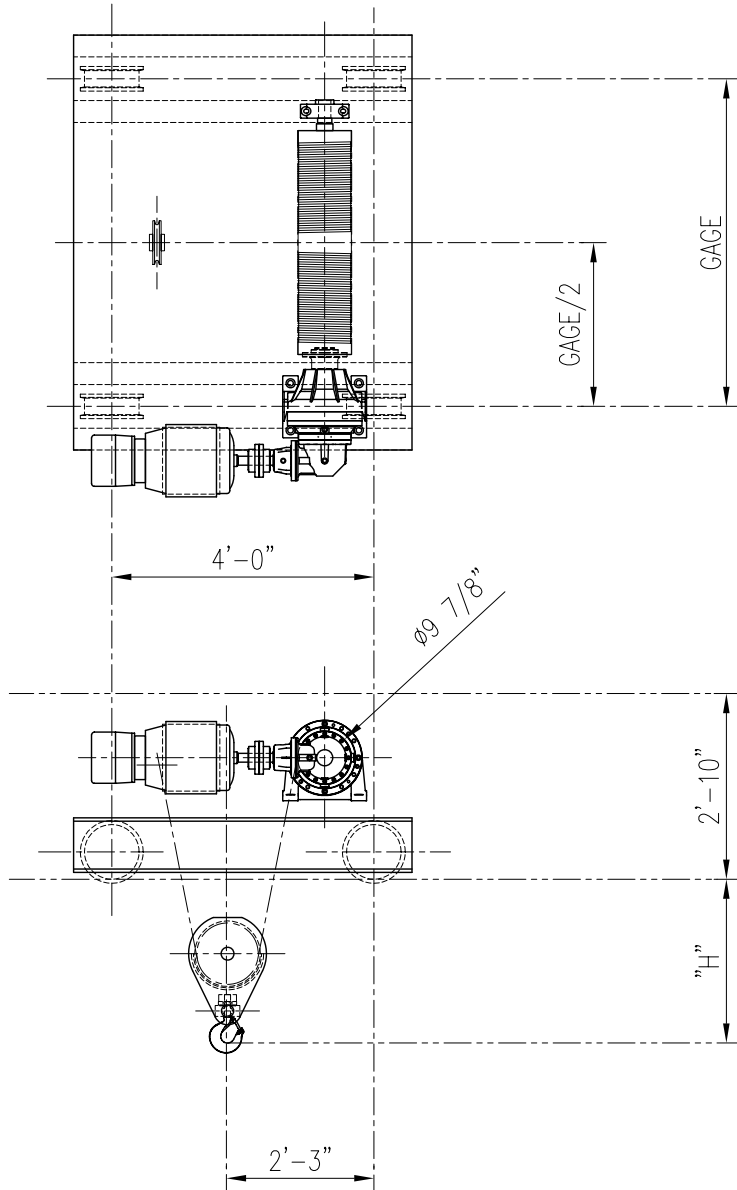

LOW HEADROOM BLOCK

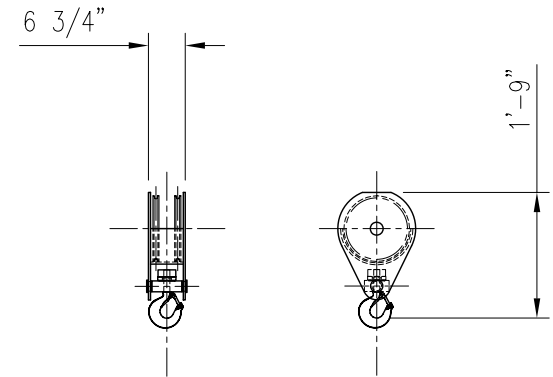

STANDARD HEADROOM BLOCK

ACECO RESERVES THE RIGHT TO MAKE CHANGES WITHOUT NOTICE.

HOIST TECHNICAL DATA

CAPACITY	5 TONS (10,000 LBS.)	HOIST SPEED	MOTOR DATA
		32 F.P.M.	12.5 HP / 1800 RPM
		27 F.P.M.	10 HP / 1800 RPM
CLASS	CMAA CLASS "D"	19 F.P.M.	7.5 HP / 1800 RPM
POWER SUPPLY	460V-3PH-60HZ		

DIMENSIONAL INFORMATION

MODEL NUMBER	GAGE	HEIGHT OF LIFT ON HOIST		H	
		STANDARD HEADROOM LOWER BLOCK	LOW HEADROOM LOWER BLOCK	STANDARD HEADROOM LOWER BLOCK	LOW HEADROOM LOWER BLOCK
20418-8005-5	5'-0"	46'-6"	40'-0"	2'-4"	1'-10"
20418-8005-6	6'-0"	64'-6"	58'-0"		
20418-8005-7	7'-0"	82'-6"	76'-0"		