



**AMERICAN CRANE
& EQUIPMENT CORPORATION**
DOUGLASSVILLE, PA. 19518 U.S.A.
PHONE: 610-385-6061
FAX: 610-385-3191

**TOP RUNNING TROLLEY
W/ OPEN DECK HOIST**

PRODUCT INFORMATION

DWG. NO:
A-20418-6075

75 TON CAPACITY

DATE: 07/20/09 REVISION: 0

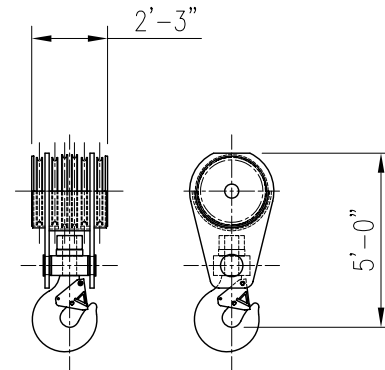
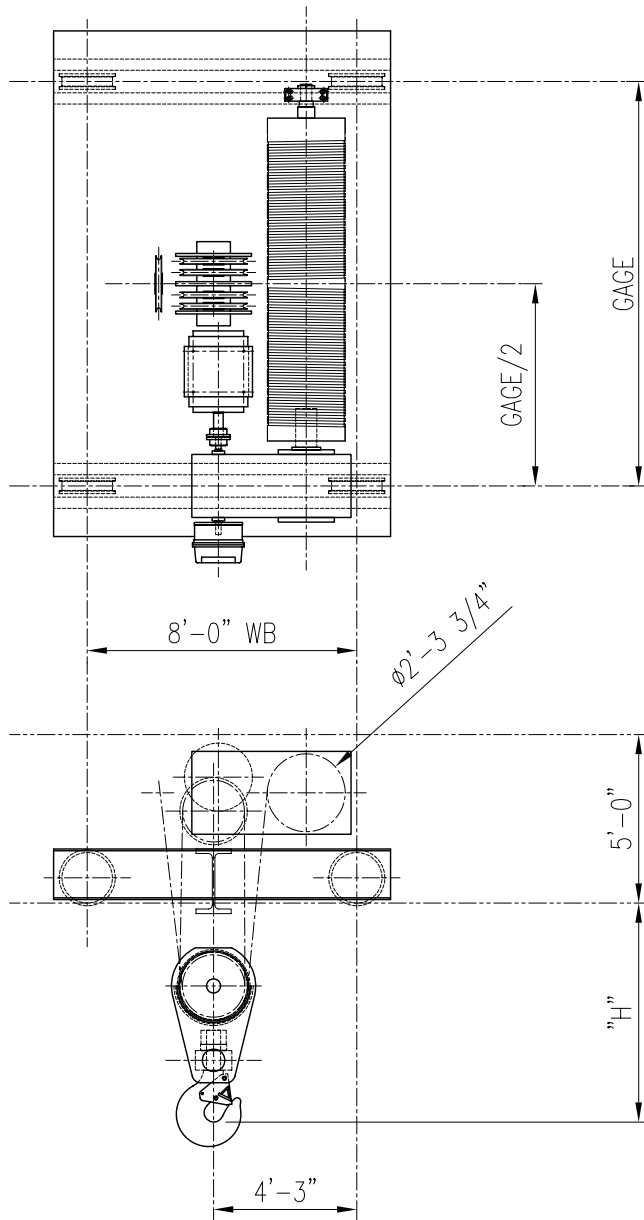

STANDARD HEADROOM BLOCK

ACECO RESERVES THE RIGHT TO MAKE CHANGES WITHOUT NOTICE.

HOIST TECHNICAL DATA

CAPACITY	75 TONS (150,000 LBS.)	HOIST SPEED	MOTOR DATA
		18 F.P.M.	100 HP / 1800 RPM
		14 F.P.M.	75 HP / 1800 RPM
CLASS	CMAA CLASS "D"	9 F.P.M.	50 HP / 1800 RPM
POWER SUPPLY	460V-3PH-60HZ		

DIMENSIONAL INFORMATION

MODEL NUMBER	GAGE	HEIGHT OF LIFT ON HOIST		H	
		STANDARD HEADROOM LOWER BLOCK	LOW HEADROOM LOWER BLOCK	STANDARD HEADROOM LOWER BLOCK	LOW HEADROOM LOWER BLOCK
20418-8075-12	12'-0"	55'-6"	NA	6'-3"	NA
20418-8075-13	13'-0"	63'-9"	NA		
20418-8075-14	14'-0"	72'-0"	NA		